



SPECIFICATION FOR APPROVAL

CUSTOMER:

MODEL NO:

AT9225L-12H2B ND1

DESCRIPTION:

DATE:

2008.12.04

CUSTOMER APPROVAL SIGNATURE

CUSTOMER APPROVED STAMP

*PLEASE RETURN ONE TO US AFTER CHECKING

UTECH

United Thermal Engineering Corporation

453 Ravendale Dr., Suite C

Mountain View, CA 94043

Tel : 650-428-1188

Fax : 650-428-1110

[E-Mail : info@utecusa.com](mailto:info@utecusa.com)

[Web Site : www.utecusa.com](http://www.utecusa.com)

PRODUCT SPECIFICATION

A.GENERAL SPECIFICATION

ITEM		SPECIFICATION/CONDITION
A-1	Part No.	AT9225L-12H2B ND1
A-2	Outline Dimension	92x92x25
A-3	Rated Voltage	12V
A-4	Operating Voltage Range	8~13.8V
A-5	Starting voltage	8V
A-6	Rated Current	0.2A(Max:0.24A)
A-7	Power Consumption	2.4W(Max:3.84W)
A-8	Rated Speed	3200RPM±10%
A-9	Max. Airflow	64.24 CFM
A-10	Max Static Pressure	5.03 mmH2O
A-11	Noise Level	40.9 dBA(Max:43.9dBA)
A-12	Rotation Direction	Anti-clockwise Direction

B.ELECTRICAL SPECIFICATION

ITEM		SPECIFICATION/CONDITION
B-1	Temperature life expectancy	70000 Hours(45°C)
B-2	Insulation Resistance	At least 10MΩ at 500VDC between housing and both lead wires.
B-3	Dielectric Strength	Withstand 600VAC 1 minute 1Ma between housing and both lead wires.

C.MAIN MATERIAL/PARTS SPECIFICATION

ITEM	MAJOR COMPONENTS	MATERIAL OR TYPE	GRADE
C-1	Housing & Impeller	Plastic	
C-2	Splash Proof	NO	
C-3	Weight	58.8g	
C-4	LEAD WIRES	UL1007#26 Single Wire	
C-5	CONNECTOR HOUSING	NP Two lead wire	
C-6	CONNECTOR		
C-7	BEARING	Ball Bearing	

D.ENVIRONMENTAL SPECIFICATION

ITEM		SPECIFICATION/CONDITION
D-1	Operation Temperature	-10°C,~+70°C, /66%(RH)
D-2	Storage Temperature	-40°C,~+70°C, /66%(RH)
D-3	Environment Humidity	Less than 85%(RH)

E-1.Shock test

Pulse shape : Half-sine wave

Shock duration time : 2ms

Velocity : 70~100 inch/sec

Number of shock : one shock for each of six faces (Total : six shocks)

E-2.Vibration

Frequency range : 10~500Hz scan 15 minutes .

Direction : X、 Y、 Z .

Acceleration : 1.5g r.m.s , each direction 2 hours .

Figure 1. Fan Performance Curve

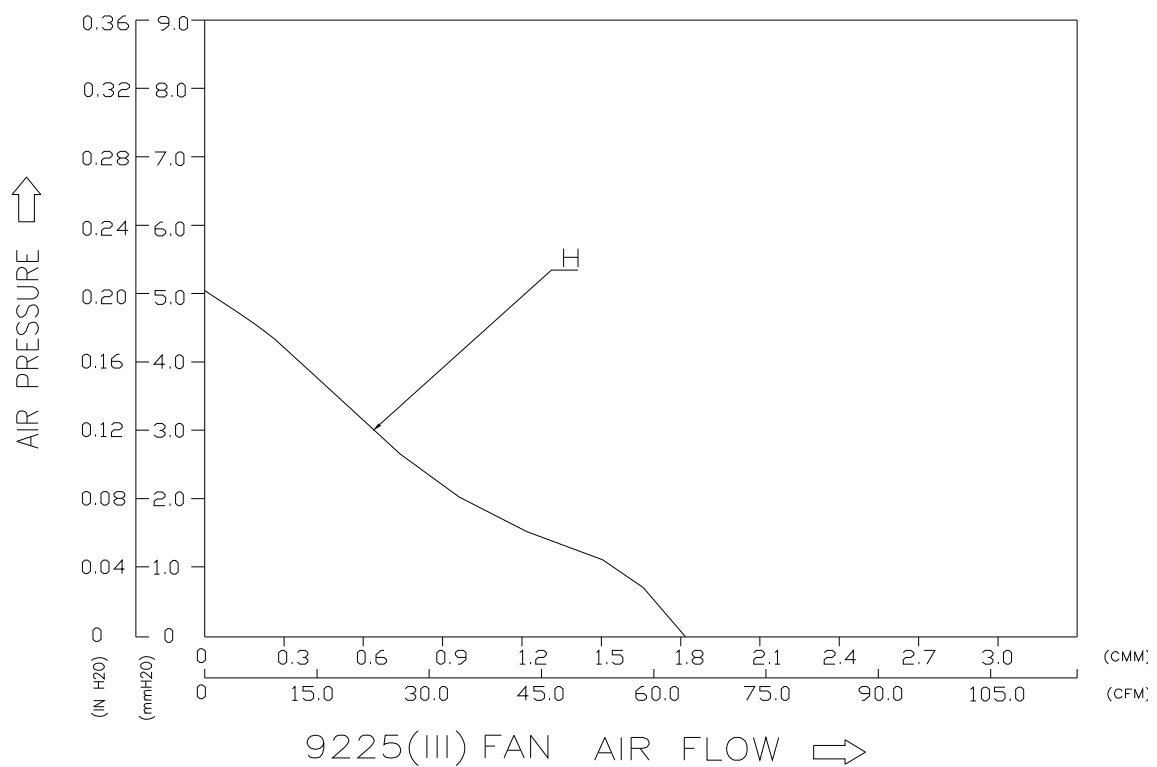
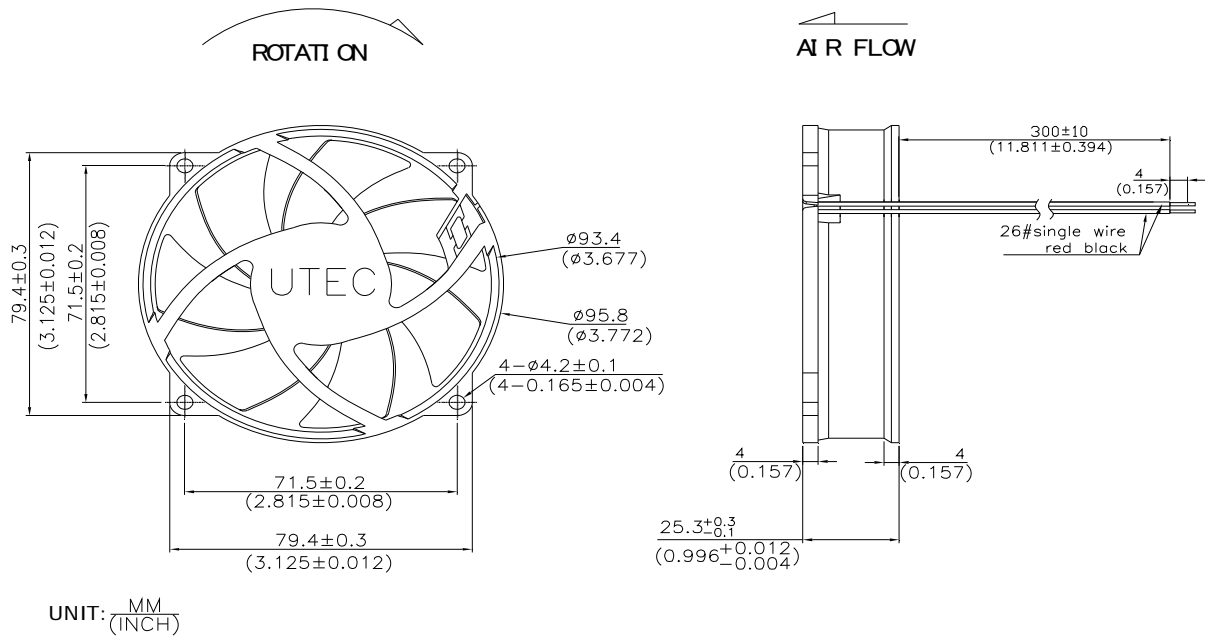

Figure 2 Fan Dimension & Assembly



Notes:

1. Tolerances:
2. Impeller must not protrude beyond front surface
3. Minimum 0.50 radius at all rib intersections
4. Unit: mm